



LP-F1 Paper Void-Fill/Cushion

Machine User Manual



Hangzhou Bing Jia Tech. Co., Ltd.

Tel: 0571-86169196 Email :info@lockedair.com

7F, Building 11, China AI TOWN 1818-2 West Wen Yi Road, Yu Hang District, Hangzhou, 31121 China

Preface

Thank you for using the Locked Paper Void Filling Machine. In order to ensure that you use the equipment correctly, be sure to read this manual carefully before operation.

Tips: The operation of different models of machines is slightly different, so please pay attention to the tips in the text of the manual.

Disclaimer

The manufacturer and its authorized distributor are not liable for any accidents or damages if one does not follow the operation steps or ignores the warning or instructions in the manual. The accidents or damages includes:

- Improper use or maintenance
- Use for other applications or conditions that the operator manual doesn't include

- Use of unauthorized parts
- Repair or modification without the permission of the manufacturer
- Unauthorized adjust to the machine such as:
 - a) Alterations to the control system
 - b) Welding and machining etc
 - c) lengthening the machine or the control system

The manufacturer and its authorized distributor are not liable for:

- Indirect damages caused by errors or malfunctions of the machine (e.g. damages to products, disruption or delays of company operation business etc.

Safety

This machine has been designed to be compatible and safe for use in the application, conditions and rules stipulated in this instruction manual. Anyone who operates the machine must carefully read this manual and follow the relevant instructions.

Operator

Only anyone who has read and understood the chapters of "Safety" and "Installation and Use of the Machine" could operate the machine. No special training is required.

Operator responsibilities include:

- Operate machine
- Perform regular maintenance (see Section 6)
 - Clean up shredded paper
 - Clean up excess paper dust

Service Technician

Only service technicians employed by Locked Paper or Locked Paper distributors are permitted to repair this machine.

We have separately prepared service manuals for these technicians.

Safety Regulations

The power used for the machine must be consistent with the parameters on the nameplate of the machine. Wrong connection is strictly prohibited. In order to prevent damage to the machine, only the power cord provided with the product can be used .

Please ensure that the power supply is reliably grounded.

When the machine is transported and moved, please pay attention to avoid occurrence of the short-circuit and open-circuit of the internal wiring of the safety switch.

Safety devices must not be turned off or removed.

Do not remove or cover warning signs (see machine warnings).

Keep the work area clean and free from obstacles.

Before moving the machine, unplug it and gather all loose wires together.

Be careful when using tools such as knives or scissors to avoid injuring your hands.

To ensure:

- No damage to cables

- Work area with good lighting
- Work area is well ventilated

Safety standard design: mechanical structure design meets CE safety standard requirements. All dangerous parts cannot be touched by hand.

Warnings

- a. When the machine is working, it is strictly forbidden to touch any rotating parts.
- b. In order to ensure the safety during equipment maintenance, the machine will not work after the front and rear covers are opened. And it is strictly forbidden to use the safety switch insert and the maintenance cover separately.
- c. Non-professionals are prohibited from opening the machine maintenance cover.
- d. Be careful not to touch the transmission wheel.



- e. During equipment maintenance, it is strictly forbidden to put fingers into the paper feed channel to avoid hands injuries.
- f. When the machine is working normally, if there are motor abnormalities, paper jams or other faults, the system will detect the sensors or motor signals, and stop to alarm.
- g. The machine will stop when the cover is opened: After the upper cover is opened, all motor power will be automatically cut off to ensure the safety of the operator.

Improper Use

The following applications or operations are inappropriate for the machine and are regarded as improper use:

- Use materials from other suppliers, not from Locked Paper
- Use outdoors or in wet areas
- Use in areas where explosion accidents may occur
- Use excess water to wash or clean the machine
- Stand on the machine
- Place objects on the machine
- Move the machine while it is running or it is still connected to AC power

Store

- Storerooms must be dry
- Do not place or store the machine in a wet or watery place



- Before using the machine again after long-term storage, it must be checked by a trained service technician

If the machine is brought from a cold area to a warm area, temporary condensation (internal and external) may occur on the machine. At this time, if it is turned on immediately, the machine would be damaged and the operator would be injured. So please make the machine recover to room temperature first and wait for the condensation to evaporate.

Transportation

- There should not be severe vibration and impact during the transportation of the machine.
- The machine should not be exposed to the sun and rain. It should be stored within the required temperature and humidity range.

1. Introduction

1.1. Product Introduction

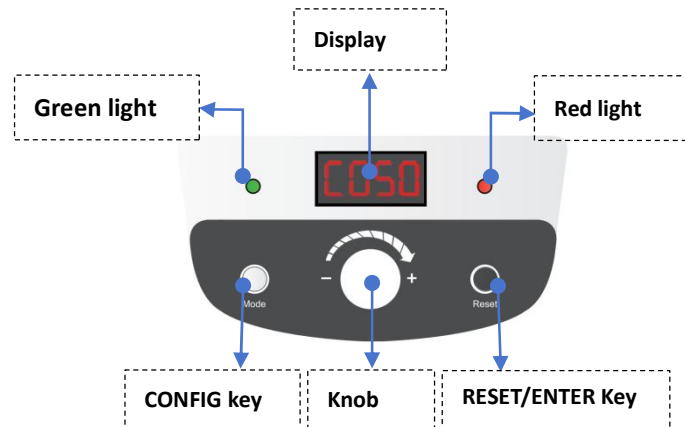

2. Operation

2.1. Installation

Please check paper machine installation diagram.

The operation method is same to different stands

Desktop Stand Assembly Preview

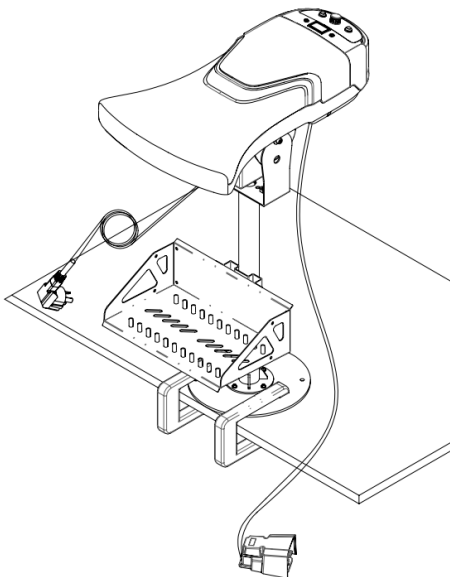

Ground Stand Assembly Preview

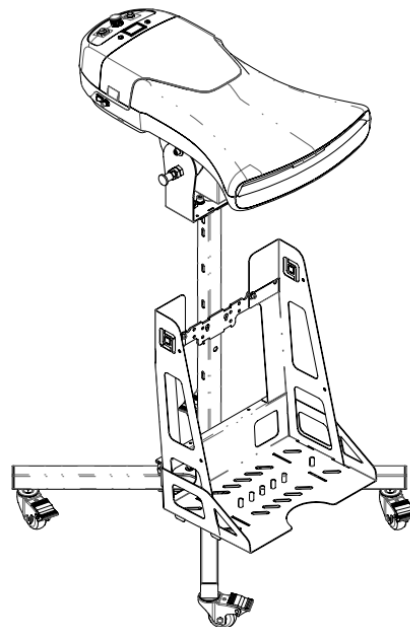

2.2. Turn the machine on

First, check that the machine meets the followings:

- Plug in the pedal switch

- All protective covers are closed
- Keep your hands away from the paper outlet of the machine (there is a cutter inside)

Then,do the following:

- 1) Plug in the power supply
- 2) Turn on the switch

Power requirement: 100~120VAC & 200~240VAC 50/60Hz

3. Detailed Operation

3.1. Power on

- a. The interface will display the version No. of Digital Tube Module software. As the picture shows, it means version V1.2.



- b. Then it will display CPU version No.: "U.E2.c" or "U.E2.i". i/c is to distinguish Metric System and Imperial System.



3.2. Feeding

When the machine is at first time-powered on or reset after alarm, if you want to load paper, make sure there isn't any paper at the Outlet, then do as following steps:

- a. Fold up the corner of the kraft paper, and then fold multiple times diagonally until the length is about 50cm.

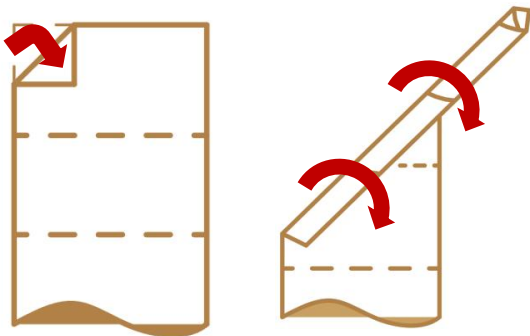

- b. Fold the folded paper in half again.

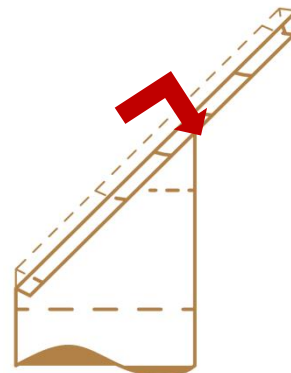

- c. Under any mode, feed the kraft paper into the Feeding port, and long press RESET to enter Loading status. FEED will appear and flash on the screen. The buzzer short beeps at long intervals. When the paper appears at the Outlet, it is judged the loading is successful. The paper feeding will stop automatically after lasting 2 mins and paper will be cut off. You can also press RESET or step on the pedal to interrupt the feeding and cut off the paper.

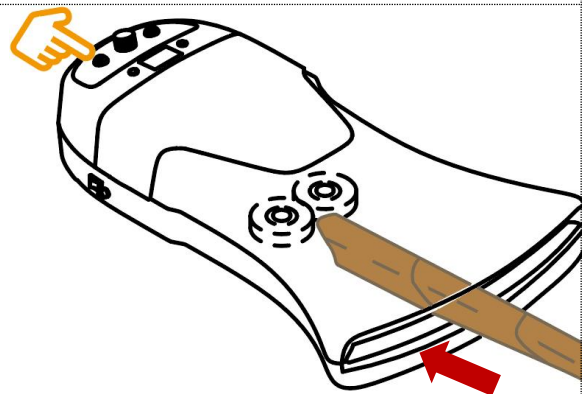













3.3. Operation Introduction

Overview :

- **Select mode:** Hold CONFIG for 2 sec, rotate the knob to select the mode, and press "ENTER" to confirm.
- **Parameter Setting :** In the interface of each mode, press RESET→CONFIG to enter the parameter editing interface. The parameter that you are editing will flash; Press CONFIG again to switch the parameter name that need to edit and rotate the knob the change the parameter. Press RESET to get out of the interface or it will exit automatically if there isn't any operation for 15s.

a. Operation Steps

Mode	Mode Selection & Parameter Setting	Operation
Manual 	<ol style="list-style-type: none"> ① Hold CONFIG for 2 sec, rotate the knob to select the mode, until the screen shows . and press "ENTER" to confirm. ② Press CONFIG into , rotate the knob to adjust the speed (Available speed range: [1, 5], 1 = 1m/s, 5 = 2m/s); ③ Press RESET to exit. 	Press the pedal, the machine will start producing paper; Release the pedal, the machine will stop producing and cut off. Minimum length of paper pad is 25cm.
Length 	<ol style="list-style-type: none"> ① Hold CONFIG for 2 sec, rotate the knob to select the mode, until the screen shows . and press "ENTER" to confirm. ② Press CONFIG into , rotate the knob to adjust the length (Available length range: [25, 450cm] & [10, 175inch]). ③ Press CONFIG again to enter , rotate the knob to adjust the speed; ④ Press RESET to exit. 	Press the pedal, the machine will start producing paper; The paper pad is produced automatically after previous one is taken out.
Count 	<ol style="list-style-type: none"> ① Hold CONFIG for 2 sec, rotate the knob to select the mode, until the screen shows . and press "ENTER" to confirm. ② Press CONFIG into , rotate the knob to adjust the quantity (Available quantity range: [1, 999]) ; ③ Press CONFIG into , rotate the knob to adjust the length. ④ Press CONFIG again to enter the interface of , rotate the knob to adjust the speed. ⑤ Press RESET to exit. 	Press the pedal, the machine will start producing paper continuously according to the preset quantity The machine will stop producing paper if you press the pedal again in process.

b. Additional Functions

Statistics Interface

① Under the interface of Mode Selection, long press CONFIG to enter the Statistics interface, The unit is km or ft. As the picture shows, it means 0.1km or 0.1ft.



② Press RESET to return to the Mode Selection interface.

c. Manual Return

Under the Mode interface, and no any alarm, press RESET and CONFIG at the same time, the paper will return about 15cm.

4. Error message and exclusion

Machine will stop and alarm when system detected abnormal motor speed, paper jam to ensure the safety of machine and packer, machine can't work till the troubleshoot, detailed alarm information and exclusion as below:

Alarm code table:

CONTENT	DETAIL	OPERAION
E001	Blade is not at starting position	Press Reset key
E002	Blade does not leave the starting position	Press Reset key Check if the plug is loose.
E003	Blade does not return to starting position	Press "RESET", check whether release or not the cover of the machine; Tighten the screws on the blade detection board(Pay attention to the installation position and screws are in the far left).
E004	No paper detected at the entrance	Check if out of paper; Press RESET, and refeed the paper.
E006	Paper jam	Find the detail below the table.
E007	Abnormal stop of feeding motor	Power off the machine, check whether the material is blocked and then power on again; Replace the control circuit board.
E008	Abnormal speed of feeding motor	Power off the machine, check whether the material is blocked and then power on again; Replace the control circuit board.
E009	Error of blade motor	Non-professional maintenance personnel please contact the after-sales in time.

Solution for paper jam inside the machine: (E006)

- ① Press Reset key, remove the alarm symbol and red light is not flashing any more;
- ② Clear the shooting exit, press foot switch again and if machine works normally, skip the following step;
- ③ If panel still display E006, hold the CONFIG key and press RESET key several times, take out all papers and then feed again;
- ④ After finish step3, the problem solved, skip following steps;
- ⑤ Unplug power plug, open the maintenance cover;
- ⑥ Clean the jammed paper and make sure that machine should be powered off during the cleaning;
- ⑦ Install the maintenance cover;

Insert the power plug into socket and feed again.

5. Maintenance

Please be sure to unplug the power plug.

- Please be careful of the sharp edges and corners of the machine to avoid injury.
- Never operate the machine when safety devices is off or removed.

The machine should be maintained at least once a week:



- Open the top cover
- Remove paper scarp
- Wipe off paper dust with a dry or slightly damp cloth
- Close the top cover
- The machine must be inspected by a qualified person at least once a year

The following points should be checked:

- Various adjustments
- The operation of various safety facilities
- If the warning label clear and legible
- Abrasion and tear of components
- Clean the molding area
- The quality of the paper pad

5.1. Repair/Replacement Parts

Repair should only be performed by a qualified service technician.

- When replacing parts, only  supplied parts can be used.
- Parts can be ordered by  's distributors.
- Failure to strictly follow the above instructions may affect the safety of the machine. The manufacturer disclaims no responsibility if the above instructions are not followed.

